

PIPE (CHS)

Fence and Gate Hardware

All measurements in millimeters (mm) unless stated otherwise.
Specifications subject to change without notice.



ROUND POST CAP		To Suit Pipe							
		CODE	D (NB)	D (OD)	T	H	Qty/Bag	Qty/Box	Box Wt (kg)
		PRE-GALVANISED							
		CR20	20	26.9	1.5	20	25	300	8
		CR25	25	33.7	1.5	23	25	200	6
		CR32	32	42.4	1.5	26	25	225	11
		CR40	40	48.3	1.5	28	25	200	12
		CR50	50	60.3	1.5	31	25	100	8
		CR65	65	76.1	1.5	34	25	75	8
		CR80	80	88.9	2.0	34	25	50	9
		CR90	90	101.6	2.0	35	-	18	5
		CR100	100	114.3	2.0	38	-	18	5
		CR125	125	139.7	2.0	40	-	22	11
		CR150	150	165.1	2.0	40	-	18	9
		HOT DIP GALVANISED							
		CR20-HDG	20	26.9	1.5	20	25	300	8
		CR25-HDG	25	33.7	1.5	23	25	200	6
		CR32-HDG	32	42.4	1.5	26	25	225	11
CR40-HDG	40	48.3	1.5	28	25	200	12		
CR50-HDG	50	60.3	1.5	31	25	100	8		
CR65-HDG	65	76.1	1.5	34	25	75	8		
CR80-HDG	80	88.9	2.0	34	25	50	9		
CR90-HDG	90	101.6	2.0	35	-	18	5		
CR100-HDG	100	114.3	2.0	38	-	18	5		
CR125-HDG	125	139.7	2.0	40	-	22	11		
CR150-HDG	150	165.1	2.0	40	-	18	9		

SQUARE POST CAP		To Suit Section						
		CODE	D	T	H	Qty/Bag	Qty/Box	Box Wt (kg)
		PRE-GALVANISED						
		CS40	40 x 40	1.5	22	25	500	17
		CS50	50 x 50	1.5	27	25	225	11
		CS51	51 x 51	1.5	27	25	225	11
		CS65	65 x 65	1.5	27	25	225	18
		CS75	75 x 75	1.5	30	25	100	11
		CS100	100 x 100	1.5	31	-	40	6

PIPE (CHS)

Fence and Gate Hardware

All measurements in millimeters (mm) unless stated otherwise.
Specifications subject to change without notice.

12

PIPE (CHS)

TEE		Code: T (thru)(butt)									
		CODE	Thru NB	Butt NB	Bolt	W	L	D	Qty/Bag	Qty/Box	Box Wt (kg)
		HOT DIP GALVANISED									
		T2020	20	20	M8 x 50	43	74	32	10	60	9
		T2025	20	25	M8 x 60	45	75	32	10	50	8
		T2520	25	20	M8 x 50	44	83	35	10	50	10
		T2525	25	25	M8 x 60	50	78	29	10	40	10
		T2532	25	32	M10 x 70	61	86	34	10	40	14
		T2540	25	40	M10 x 80	66	100	49	10	40	18
		T3225	32	25	M10 x 60	50	95	40	10	40	13
		T3232	32	32	M10 x 70	60	100	40	10	40	17
		T3240	32	40	M10 x 75	68	110	49	10	40	19
		T3250	32	50	M10 x 90	78	114	49	10	40	24
		T4025	40	25	M10 x 60	61	107	39	10	40	16
		T4032	40	32	M10 x 70	63	117	51	10	50	22
		T4040	40	40	M10 x 75	115	68	50	10	50	26
		T4050	40	50	M10 x 90	78	120	52	10	40	26
		T5025	50	25	M10 x 60	64	118	40	10	30	15
		T5032	50	32	M10 x 75	63	125	44	10	40	20
		T5040	50	40	M10 x 85	68	126	51	10	20	12
		T5050	50	50	M10 x 90	77	130	52	10	20	14
		T6550	65	50	M12 x 100	89	157	60	10	20	26
T8032	80	32	M10 x 85	72	160	55	10	20	20		
T8040	80	40	M10 x 85	73	162	57	10	20	22		
T10032	100	32	M10 x 85	72	176	55	10	20	20		
T10040	100	40	M10 x 90	73	178	55	10	20	23		

CROSS		Code: X (thru)(butt)									
		CODE	Thru NB	Butt NB	Bolt	H	L	D	Qty/Bag	Qty/Box	Box Wt (kg)
		HOT DIP GALVANISED									
		X2520	25	20	M8 x 60	45	115	31	10	60	18
		X2525	25	25	M8 x 60	45	118	32	10	50	17
		X3225	32	25	M10 x 60	49	148	38	10	50	22
		X3232	32	32	M10 x 70	56	143	38	10	20	10
		X4032	40	32	M10 x 75	60	165	44	10	20	12
		X4040	40	40	M10 x 75	66	165	46	10	20	13
		X5025	50	25	M10 x 70	64	172	41	10	20	13
		X5032	50	32	M10 x 75	68	185	50	10	20	16
		X5040	50	40	M10 x 85	67	194	53	10	20	16
		X5050	50	50	M12 x 100	75	198	53	10	20	18
		X6550	65	50	M12 x 100	90	230	63	10	10	17

PIPE (CHS)

Fence and Gate Hardware

All measurements in millimeters (mm) unless stated otherwise.
Specifications subject to change without notice.

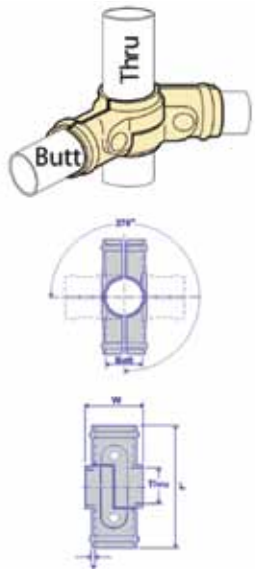
ADJUSTABLE CORNER		Code: AC (thru)(butt)									
	CODE	Thru NB	Butt NB	Bolt	T	L	W	Qty/Bag	Qty/Box	Box Wt (kg)	
	HOT DIP GALVANISED										
	AC2525	25	25	M8x60	3.0	155	54	10	40	19	
	AC3225	32	25	M10x60	3.0	165	54	10	40	20	
	AC3232	32	32	M10x70	3.0	183	65	5	25	16	
	AC4032	40	32	M10x70	3.0	183	65	5	20	14	
	AC4040	40	40	M10x75	3.0	188	71	5	20	16	
	AC5025	50	25	M10x70	3.0	180	53	5	25	15	
	AC5032	50	32	M10x70	3.0	180	65	5	10	8	
	AC5040	50	40	M10x75	3.0	190	71	5	20	16	
AC5050	50	50	M10x85	3.0	200	83	5	20	23		

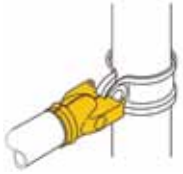
UNIVERSAL FITTING		Code: UFR (thru)(butt)								
	RAIL CLAMP									
	under development									
	CODE	To Suit pipe NB	OD	W	L	D	Qty/Bag	Qty/Box	Box Wt (kg)	
	HOT DIP GALVANISED									
UFR32	32	42.4								
UFR40	40	48.3								
UFR50	50	60.3								

UNIVERSAL FITTING		Code: UFP (thru)(butt)								
	POST BAND									
	under development									
	CODE	To Suit pipe NB	OD	W	L	D	Qty/Bag	Qty/Box	Box Wt (kg)	
	HOT DIP GALVANISED									
UFP32	32	42.4								
UFP40	40	48.3								
UFP50	50	60.3								
UFP65	65	76.1								
UFP80	80	88.9								
UFP100	100	114.3								
UFP150	150	165.1								

PIPE (CHS)

Fence and Gate Hardware

All measurements in millimeters (mm) unless stated otherwise.
Specifications subject to change without notice.

14

PIPE (CHS)

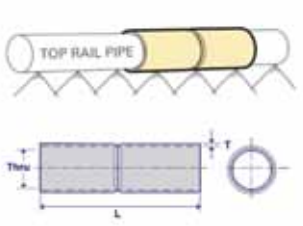
PIPE SLEEVE		To Suit pipe					
	CODE	Thru NB	Thru OD	T	L	Qty/Box	Box Wt (kg)
	HOT DIP GALVANISED						
	PS32	32	42.4	1.5	180	50	18
	PS40	40	48.3	1.5	200	25	11
	PS50	50	60.3	1.5	250	20	11

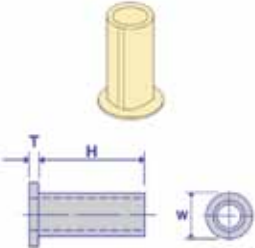
NYLON SLEEVE									
	CODE	To Suit Pin	To Suit Socket	H	T	W	Qty/Bag	Qty/Box	Box Wt (kg)
		SL16	12	16	37	2.0	25	10	250

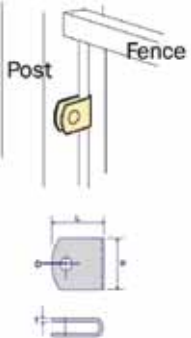
MESH CLIP								
	CODE	To Suit Rod D	H	L	T	Qty/Bag	Qty/Box	Box Wt (kg)
	HOT DIP GALVANISED							
	MC6	5-6	25	30	1.0	100	600	8
	MC8	7-8	25	30	1.0	100	600	8

PIPE (CHS)

Fence and Gate Hardware

All measurements in millimeters (mm) unless stated otherwise.
Specifications subject to change without notice.

BRACKET

CODE	To Suit Section	F	W	H	G	Qty/Bag	Qty/Box	Box Wt (kg)
PRE-GALVANISED								
BT26S-1h	25 x 25		33	60	23	25	150	5
BT26S-2h	25 x 25	63	37	90	23	25	150	6
BT31S-2h	30 x 30		40	62	24	25	150	6
BT4025RE-2h	40 x 25	under development						

CODE	To Suit Section	To Suit Pipe	W	H	H1	D1	Qty/Box	Box Wt (kg)
HOT-DIP GALVANISED								
BT30SE	30 x 30		44	30	38	9x20	420	20
BT4025RE	40 x 25		40	25	45	9x20	336	22
BT3040SE	30 x 30	40	98	30	46	9x20	336	22
BT40E-ANG	UNIV.	under development						

BT26S-1h

BT26S-2h

BT31S-2h & BT4025RE-2h

BT30SE & BT4025RE

BT3040SE

15
PIPE (CHS)

WELD-ON PIPE FLANGE - OVAL

CODE	To Suit pipe		W	L	T	Qty/Bag	Qty/Box	Box Wt (kg)
	D (NB)	D (OD)						
HOT-DIP GALVANISED								
F025P-2h	25	33.7	69	106	3.0	10	60	8
F032P-2h	32	42.4	88	130	4.5	10	40	12
F040P-2h	40	48.3	95	130	4.5	10	40	13
F050P-2h	50	60.3	105	130	4.5	10	40	14

PIPE (CHS)

Fence and Gate Hardware

All measurements in millimeters (mm) unless stated otherwise.
Specifications subject to change without notice.

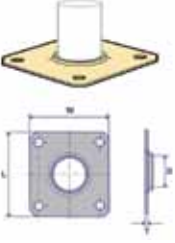
WELD-ON PIPE FLANGE - SQUARE									
	CODE	To Suit pipe		W	L	T	Qty/Bag	Qty/Box	Box Wt (kg)
		D (NB)	D (OD)						
HOT DIP GALVANISED									
	FS32P-4h	32	42.4	130	130	4.5	10	40	20
	FS40P-4h	40	48.3	130	130	4.5	10	40	20
	FS50P-4h	50	60.3	130	130	4.5	10	40	19

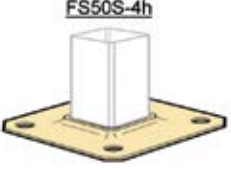
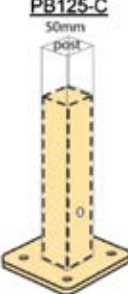
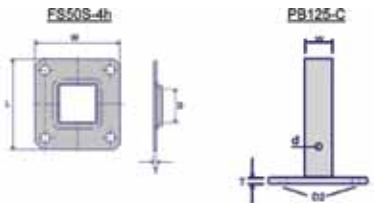
WELD-ON SECTION FLANGE - SQUARE									
	CODE	To Suit section		L	T	Qty/Bag	Qty/Box	Box Wt (kg)	
		D	W						
HOT DIP GALVANISED									
	FS50S-4h	50	125	125	4.5	10	40	19	
	CODE	W	d	D2	T	Qty/Bag	Qty/Box	Box Wt (kg)	
	HOT DIP GALVANISED								
	PB125-C	80	12.5	43	4.5	10	40	19	
									

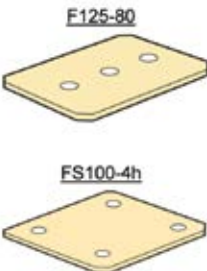
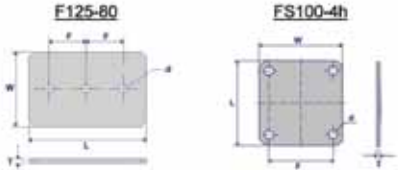
ALL PURPOSE FLANGE									
	CODE	To Suit pipe		L	W	Qty/Bag	Qty/Box	Box Wt (kg)	
		F	d						
HOT DIP GALVANISED									
	F125-80	43	13	5.0	125	80	10	60	22
	FS100-4h	58	12	6.0	100	100	10	40	18
									

16

PIPE (CHS)

PIPE (CHS)

Fence and Gate Hardware

All measurements in millimeters (mm) unless stated otherwise.
Specifications subject to change without notice.

WELD-ON SOCKET									
	CODE	To Suit pin D (OD)	L	H	T	Qty/Bag	Qty/Box	Box Wt (kg)	
	HOT DIP GALVANISED								
	SW16	16	31	41	3.0	20	200	14	
	SW20	20	41	41	4.5	10	100	16	
	SW20H	20	41	50	4.5	10	100	11	
	ZINC PLATED								
	SW16-ZP	16	31	41	3.0	20	200	14	
	SW20-ZP	20	41	41	4.5	10	100	15	
	SW20H-ZP	20	41	50	4.5	10	100	11	
	UNGALVANISED								
SW16-B	16	31	41	3.0	20	200	14		
SW20-B	20	41	41	4.5	10	100	15		
SW20H-B	20	41	50	4.5	10	100	11		

WELD-ON GUDGEON									
	CODE	To Suit socket D (ID)	L	H1	H2	Qty/Bag	Qty/Box	Box Wt (kg)	
	HOT DIP GALVANISED								
	GW16S	16	39	91	50	10	100	22	
	GW20S	20	46	90	50	10	50	19	
	GW20L	20	46	112	70	10	40	17	
	ZINC PLATED								
	GW16S-ZP	16	39	91	50	10	100	22	
	GW20S-ZP	20	46	90	50	10	50	19	
	UNGALVANISED								
	GW16S-B	16	39	91	50	10	100	22	
GW20S-B	20	46	90	50	10	50	19		

WELD-ON PIN									
	CODE	To Suit socket D (ID)	H1	H2	Qty/Bag	Qty/Box	Box Wt (kg)		
	ZINC PLATED								
	PW16S-ZP	16	90	42	10	100	17		
	PW20L-ZP	20	125	70	10	100	32		

PIPE (CHS)

Fence and Gate Hardware

All measurements in millimeters (mm) unless stated otherwise.
Specifications subject to change without notice.

SCREW-ON PLATE GUDGEON									
To suit socket CODE	ID	H1	H2	W	G	Qty/Bag	Qty/Box	Box Wt (kg)	HOT DIP GALVANISED
									HOT DIP GALVANISED
GSP16S	16	141	41	48	28	-	30	16	
GSP20S	20	124	52	79	28	-	16	14	
GSP16S-L	16	130	41	35	20	10	60	19	
GSP20S-L	20	130	52	35	20	10	60	23	
ZINC PLATED									
GSP16S-ZP	16	141	41	48	28	-	30	16	
GSP20S-ZP	20	124	52	79	28	-	16	14	
GSP16S-LZP	16	130	41	35	20	10	60	19	
GSP20S-LZP	20	130	52	35	20	10	60	23	

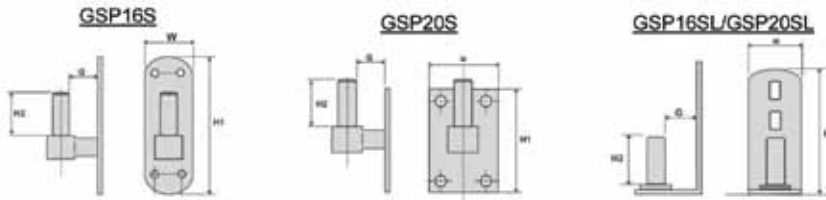
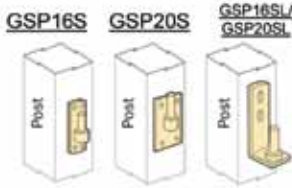

THRU POST GUDGEON									
CODE	H2	D1	D2	L1	8mm Pin Locking Hole	Qty/Bag	Qty/Box	Box Wt (kg)	HOT DIP GALVANISED
									HOT DIP GALVANISED
GT12S100	41	12	12	100	N	10	60	10	
GT12S190	41	12	12	190	N	10	50	12	
GT16S200	50	16	16	200	N	10	20	9	
GT16S250	50	16	16	250	N	10	30	17	
GT20S275	50	20	20	275	N	5	20	16	
GT20L275	70	20	20	275	Y	5	20	17	
GT20S350	50	20	20	350	N	5	20	24	
GT20L350	70	20	20	350	Y	5	20	25	
ZINC PLATED									
GT12S100-ZP	41	12	12	100	N	10	60	10	
GT12S190-ZP	41	12	12	190	N	10	50	12	
GT16S200-ZP	50	16	16	200	N	10	20	9	
GT16S250-ZP	50	16	16	250	N	10	30	17	
GT20S275-ZP	50	20	20	275	N	5	20	16	
GT20L275-ZP	70	20	20	275	Y	5	20	17	
GT20S350-ZP	50	20	20	350	N	5	20	24	
GT20L350-ZP	70	20	20	350	Y	5	20	25	

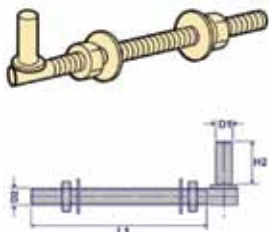

PIPE (CHS)

Fence and Gate Hardware

All measurements in millimeters (mm) unless stated otherwise.
Specifications subject to change without notice.

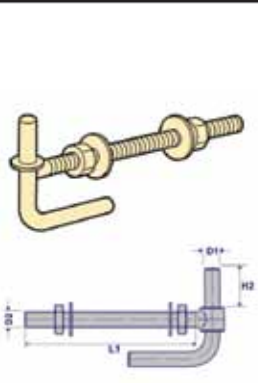
LOCKTHRU POST GUDGEON									
	CODE	H2	D1	D2	L1	8mm Pin Locking Hole	Qty/Bag	Qty/Box	Box Wt (kg)
	HOT DIP GALVANISED								
	GLT16S250	50	16	16	250	N	5	20	16
	GLT20S275	50	20	20	275	N	5	10	14
	GLT20L275	70	20	20	275	Y	5	10	14
	GLT20S350	50	20	20	350	N	5	10	15
	GLT20L350	70	20	20	350	Y	5	10	16
ZINC PLATED									
	GLT16S250-ZP	50	16	16	250	N	5	20	16
	GLT20S275-ZP	50	20	20	275	N	5	10	14
	GLT20L275-ZP	70	20	20	275	Y	5	10	14
	GLT20S350-ZP	50	20	20	350	N	5	10	15
	GLT20L350-ZP	70	20	20	350	Y	5	10	16

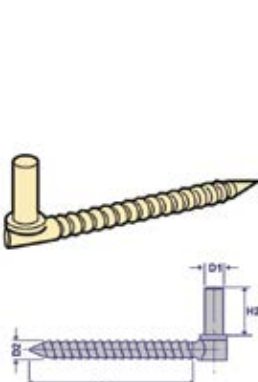
SCREW GUDGEON									
	CODE	H2	D1	D2	L1	8mm Pin Locking Hole	Qty/Bag	Qty/Box	Box Wt (kg)
	HOT DIP GALVANISED								
	GS12S100	39	12	12	100	N	10	80	12
	GS16S105	50	16	16	105	N	10	50	14
	GS16S140	50	16	16	140	N	10	50	16
	GS20S150	50	20	20	150	N	10	20	12
	GS20L150	70	20	20	150	Y	10	20	12
	GS20S200	50	20	20	200	N	10	20	14
	GS20L200	70	20	20	200	Y	10	20	14
ZINC PLATED									
	GS12S100-ZP	39	12	12	100	N	10	80	12
	GS16S105-ZP	50	16	16	105	N	10	50	14
	GS16S140-ZP	50	16	16	140	N	10	50	16
	GS20S150-ZP	50	20	20	150	N	10	50	12
	GS20L150-ZP	70	20	20	150	Y	10	20	12
	GS20S200-ZP	50	20	20	200	N	10	20	14
	GS20L200-ZP	70	20	20	200	Y	10	20	14

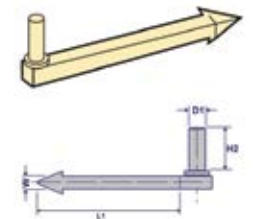
DRIVE GUDGEON									
	CODE	H2	D1	L1	W	8mm Pin Locking Hole	Qty/Bag	Qty/Box	Box Wt (kg)
	HOT DIP GALVANISED								
	GD20L200	70	20	200	19x19	Y	5	20	17
ZINC PLATED									
	GD20L200-ZP	70	20	200	19x19	Y	5	20	17

PIPE (CHS)

Fence and Gate Hardware

All measurements in millimeters (mm) unless stated otherwise.
Specifications subject to change without notice.

20

PIPE (CHS)

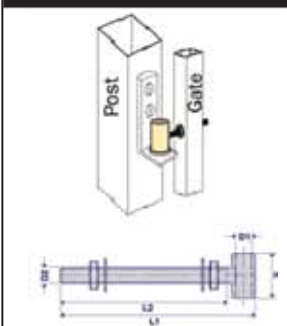
ADJUSTABLE SOCKET									
	CODE	To Suit Pin D1	L1	L2	H	D2	Qty/Bag	Qty/Box	Box Wt (kg)
	HOT DIP GALVANISED								
	SA16-120	16	145	113	40	15	10	40	13
	SA20-120	20	150	113	40	15	10	40	14

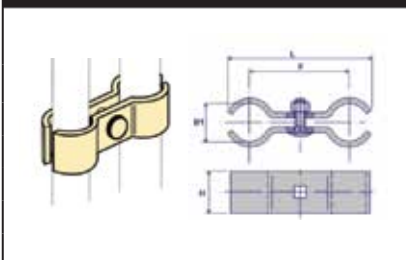
TEMPORARY FENCE CLAMP									
	CODE	To Suit Pipe D1 (NB)	L	F	H	Qty/Bag	Qty/Box	Box Wt (kg)	
	HOT DIP GALVANISED								
	TFC2525-S	25	109	70	35	10	40	15	
	TFC2525	25	130	90	35	10	40	17	
	TFC2525-L	25	123	90	40	10	40	11	
	TFC3232	32	128	91	55	10	40	21	
	TFC3232-L	32	128	91	55	10	50	19	

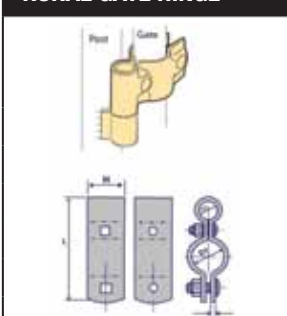
RURAL GATE HINGE										
	CODE	To Suit Pin D1	To Suit Pipe D2	H	T	L	Bolt/Nut	Qty/Bag	Qty/Box	Box Wt (kg)
	HOT DIP GALVANISED									
	HC2016	20	16	40	3.0	86	M8 x 50/M8 x 35	10	80	18
	HC2520	25	20	40	3.0	110	M10 x 30	10	50	26
ZINC PLATED										
	HC2016-ZP	20	16	40	3.0	86	M8 x 50/M8 x 35	10	80	18
	HC2520-ZP	25	20	40	3.0	110	M10 x 30	10	50	26

PIPE (CHS)

Fence and Gate Hardware

All measurements in millimeters (mm) unless stated otherwise.
Specifications subject to change without notice.

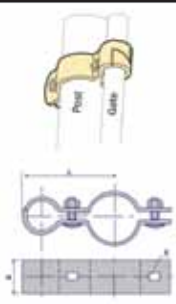
GATE POST HINGE										
	CODE	Post (NB)	Gate (NB)	L	H	d	Bolt/Nut	Qty/Bag	Qty/Box	Box Wt (kg)
	HOT DIP GALVANISED									
	HP4025	40	25	60	40	11x11	M10 x 40/M10 x 35	4	20	10
	HP5025	50	25	70	40	11x11	M10 x 40/M10 x 35	4	20	11
	HP5032	50	32	72	40	11x11	M10 x 40/M10 x 35	4	20	12
	HP8025	80	25	83	40	11x11	M10 x 40/M10 x 35	4	20	16
	HP8032	80	32	89	40	11x11	M10 x 40/M10 x 35	4	20	17
	HP10032	100	32	100	40	11x11	M10 x 40/M10 x 35	4	20	20

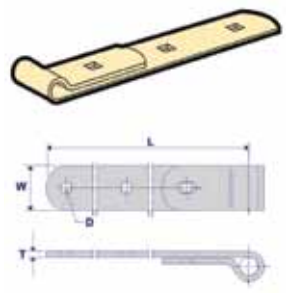
HINGE STRAP										
	CODE	To Suit Pin	Attachment Holes	D	T	L	W	Qty/Bag	Qty/Box	Box Wt (kg)
	HOT DIP GALVANISED									
	HS16-150	16	2	11 x 11	5.0	150	30	10	40	11
	HS16-225	16	2	11 x 11	5.0	225	40	10	30	17
	HS16-300	16	3	11 x 11	5.0	300	40	10	20	16
	HS20-300	20	3	11 x 11	6.0	300	50	10	20	19
	HS20-375	20	3	11 x 11	6.0	375	50	10	20	22
	HS20-450	20	3	11 x 11	6.0	450	50	10	20	26
	HS20-600	20	4	12 x 12	6.0	600	50	5	20	32
ZINC PLATED										
	HS16-150-ZP	16	2	11 x 11	5.0	150	30	10	40	11
	HS16-225-ZP	16	2	11 x 11	5.0	225	40	10	30	17
	HS16-300-ZP	16	3	11 x 11	5.0	300	40	10	20	16
	HS20-300-ZP	20	3	11 x 11	6.0	300	50	10	20	19
	HS20-375-ZP	20	3	11 x 11	6.0	375	50	10	20	22
	HS20-450-ZP	20	3	11 x 11	6.0	450	50	10	20	26
	HS20-600-ZP	20	4	12 x 12	6.0	600	50	5	20	32

21

PIPE (CHS)

PIPE (CHS)

Fence and Gate Hardware

All measurements in millimeters (mm) unless stated otherwise.
Specifications subject to change without notice.

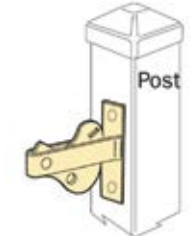

22

PIPE (CHS)

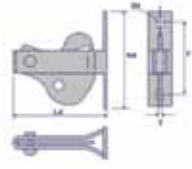
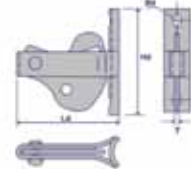
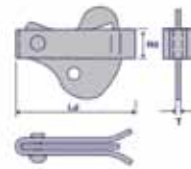
GATE "D" LATCH									
 DL-BF (bolt-on, flat surface)	CODE	Hd	F	Ld	T	Dd	Qty/Bag	Qty/Box	Box Wt (kg)
	HOT DIP GALVANISED								
	DL-BR	99	79	84	5.0	10 x 7	10	40	12
	DL-WR	20	-	82	5.0	-	10	40	9
	DL-BF	99	79	80	5.0	10 x 7	10	40	12
ZINC PLATED									
	DL-BR-ZP	99	79	84	5.0	10 x 7	10	40	12
	DL-WR-ZP	20	-	82	5.0	-	10	40	9
	DL-BF-ZP	99	79	80	5.0	10 x 7	10	40	12

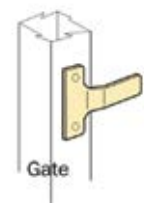
DL-BF (bolt-on, flat surface)	DL-BR (bolt-on, round surface)	DL-WR (weld-on)
		

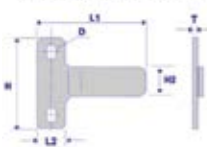
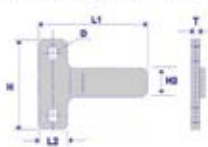
GATE "D" LATCH STRIKER										
 DL-BFS (bolt-on, flat surface)	CODE	H	H2	L1	L2	T	D	Qty/Bag	Qty/Box	Box Wt (kg)
	HOT DIP GALVANISED									
	DL-BRS	60	20	95	22	4.0	10 x 7	10	200	15
	DL-WRS	-	20	93	-	4.0	-	10	200	12
	DL-WFS	-	20	100	-	4.0	-	10	200	13
	DL-BFS	60	20	81	22	4.0	10 x 7	10	200	16
ZINC PLATED										
	DL-BRS-ZP	60	20	95	22	4.0	10 x 7	10	200	15
	DL-WRS-ZP	-	20	93	-	4.0	-	10	200	12
	DL-WFS-ZP	-	20	100	-	4.0	-	10	200	13
	DL-BFS-ZP	60	20	81	22	4.0	10 x 7	10	200	16

DL-BFS (bolt-on, flat surface)	DL-BRS (bolt-on, round surface)	DL-WFS (weld-on, flat surface)	DL-WRS (weld-on, round surface)
			

PIPE (CHS)

Fence and Gate Hardware

All measurements in millimeters (mm) unless stated otherwise.
Specifications subject to change without notice.

GATE "D" LATCH ARM							
	CODE	L	H	D	Qty/Bag	Qty/Box	Box Wt (kg)
	HOT DIP GALVANISED						
	DL-Arm	165	40	6	50	250	15
	ZINC PLATED						
	DL-Arm-ZP	165	40	6	50	250	15

DRAW BOLT									
	CODE	D	D1	D2	L	H	L1	Qty/Bag	Wt (kg)
	HOT DIP GALVANISED								
	DBC650	20	16	11 x 11	650	49	148	1	3.2

RURAL GATE FASTENER										
	CODE	Tf	Tc	Lf	Lc	Ls	Ts	Qty/Bag	Qty/Box	Box Wt (kg)
	HOT DIP GALVANISED									
	FG-L (latch)	9	5	85	235	100	7	-	-	-
	FG-S (staple)	-	-	-	-	100	7	10	160	10
	FGF-H (set)	9	5	100	235	100	7	10	40	13
	FGS-H (set)	9	5	100	235	100	7	10	40	13
	ZINC PLATED									
	FG-L-ZP (latch)	9	5	85	235	100	7	-	-	-
	FG-S-ZP (staple)	-	-	-	-	100	7	10	160	10
	FGF-H-ZP (set)	9	5	100	235	100	7	10	40	13
	FGS-H-ZP (set)	9	5	100	235	100	7	10	40	13
FG-S	Staple									
FG-L	Light duty gate fastener									
FGF-H	Heavy duty floppy ring gate fastener									
FGS-H	Heavy duty spring ring gate fastener									

PIPE (CHS)

Fence and Gate Hardware

All measurements in millimeters (mm) unless stated otherwise.
Specifications subject to change without notice.

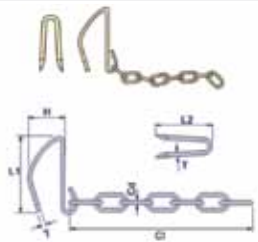
SHEEP YARD GATE FASTENER											
	CODE	L1	L2	H	C1	C2	T	Qty/Bag	Qty/Box	Box Wt (kg)	
	HOT DIP GALVANISED										
	FG-SY (latch)	65	-	40	305	5	6	10	160	10	
FG-SYS (staple)	-	80	-	-	-	6	50	250	8.75		

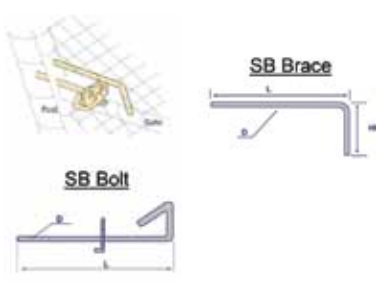
SHOOT BOLT								
	CODE	L	H	D	Qty/Bag	Qty/Box	Box Wt (kg)	
	HOT DIP GALVANISED							
	SB155 (Shoot bolt & guide)	155	55	12	10	60	16	
SB310 (Shoot bolt & guide)	310	55	12	10	60	25		
SB310	122	102	12	10	100	18		

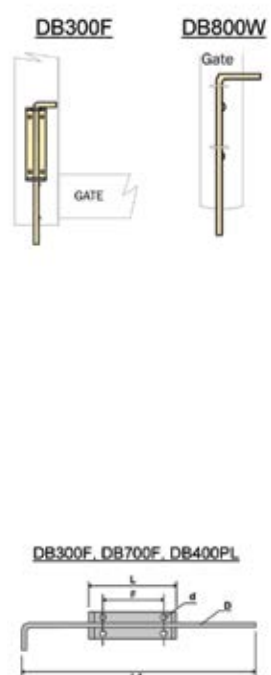
DROP BOLT										
	CODE	L1	L	F	d	D	Qty/Bag	Qty/Box	Box Wt (kg)	
	HOT DIP GALVANISED									
	DB300F	310	120	90	6	14	10	30	18	
DB700F	710	120	90	6	12	10	20	17		
DB400PL	400	190	7	5	10	10	50	22		
CODE	L1	L2	W	D	Qty/Bag	Qty/Box	Box Wt (kg)			
HOT DIP GALVANISED										
DB450W	450	-	90	16	10	20	19			
DB800W	800	480	90	16	10	10	15			
CODE	L1	L2	W	D	D2	Qty/Bag	Qty/Box	Box Wt (kg)		
HOT DIP GALVANISED										
DB1050WL	1050	17	120	16	8	10	10	18		
DB1200WL	1200	17	120	16	8	10	10	20		
DB1500WL	1500	17	120	16	8	10	10	22		

24

PIPE (CHS)

PIPE (CHS)

Fence and Gate Hardware

All measurements in millimeters (mm) unless stated otherwise.
Specifications subject to change without notice.

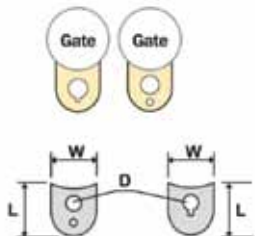
DROP BOLT LUG							
	CODE	L	W	D	Qty/Bag	Qty/Box	Box Wt (kg)
	HOT DIP GALVANISED						
	DBL16	37	32	18	10	300	18

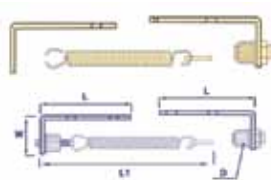
SELF-CLOSING HINGE								
	CODE	D	W	L	L1	Qty/Bag	Qty/Box	Box Wt (kg)
	ZINC PLATED							
	GH25ADJ-2P	22.4	59	127	260	1	20	12

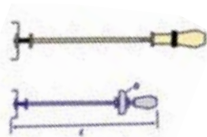
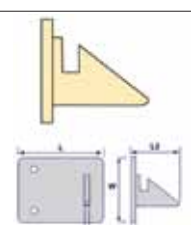
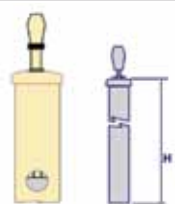
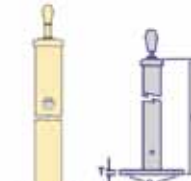
SELF-CLOSING LATCH						
	CODE	D	L	Wt (kg)		
	HOT DIP GALVANISED					
	PGL1	50 x 50	100	0.349		
PGL1 Self closing latch to fit internally into a 50mm post						
	CODE	L2	T	L	W	Wt (kg)
	HOT DIP GALVANISED					
	PGLS-LO&RO	38	5.0	85	60	0.204
LO Left-hand opening RO Right-hand opening						
	CODE	H	Wt (kg)			
	HOT DIP GALVANISED					
	PGL1-P	2200	4.350			
PGL1-P Pre-installed into 2.2m pre-galvanized post						
	CODE	D	T	H	Wt (kg)	
	HOT DIP GALVANISED					
	PGL1-PF	12.5	5.0	1600	4.837	
PGL1-PF Pre-installed into 2.2m pre-galvanized flanged post						

PIPE (CHS)

Fence and Gate Hardware

All measurements in millimeters (mm) unless stated otherwise.
Specifications subject to change without notice.

26

PIPE (CHS)

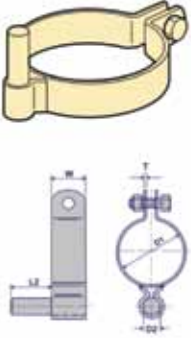
CENTRE BAND GUDGEON										
	CODE	To suit pipe		D2	T	L2	W	Bolt/Nut	Qty/Box	Box Wt (kg)
		D1 (NB)	D1 (OD)							
HOT DIP GALVANISED										
	CBG16-25	25	33.7	16	3.0	41	42	M10 x 50	32	14
	CBG16-32	32	42.4	16	3.0	41	42	M10 x 50	25	12
	CBG16-40	40	48.3	16	3.0	41	42	M10 x 50	24	12
	CBG16-50	50	60.3	16	3.0	41	42	M10 x 60	16	8
	CBG20-40	40	48.3	20	3.0	41	42	M10 x 50	18	12
	CBG20-50	50	60.3	20	3.0	41	42	M10 x 60	16	11
	CBG20-65	65	76.1	20	3.0	41	42	M10 x 60	20	15
	CBG20-80	80	88.9	20	3.0	41	42	M10 x 60	17	13
	CBG20-90	90	101.6	20	3.0	41	42	M10 x 30	16	13
	CBG20-100	100	114.3	20	3.0	41	42	M10 x 60	13	11
	CBG20-125	125	139.7	20	3.0	41	42	M10 x 30	31	29
	CBG20-150	150	165.1	20	3.0	41	42	M10 x 60	21	22

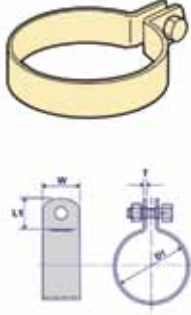
CENTRE BAND HEAVY DUTY										
	CODE	To suit pipe		T	L1	W	Bolt/Nut	Qty/Box	Box Wt (kg)	
		D1 (NB)	D1 (OD)							
HOT DIP GALVANISED										
	CB25-H	25	33.7	3.0	40	42	M10 x 50	50	21	
	CB32-H	32	42.4	3.0	40	42	M10 x 50	36	9	
	CB40-H	40	48.3	3.0	40	42	M10 x 50	32	9	
	CB50-H	50	60.3	3.0	40	42	M10 x 60	48	15	
	CB65-H	65	76.1	3.0	40	42	M10 x 60	30	11	
	CB80-H	80	88.9	3.0	40	42	M10 x 60	28	11	
	CB90-H	90	101.6	3.0	40	42	M10 x 30	20	9	
	CB100-H	100	114.3	3.0	40	42	M10 x 60	18	9	
	CB125-H	125	139.7	3.0	40	42	M10 x 30	40	23	
	CB150-H	150	165.1	3.0	40	42	M10 x 60	30	19	

PIPE (CHS)

Fence and Gate Hardware

All sizes are in millimeters (mm) and weights are in kg's unless stated otherwise.
Specifications subject to change without notice.

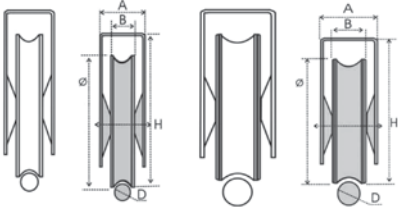
UNDER GATE WHEELS - U		CODE	Bearing	Ø	A	B	D	H	Loading Capacity	Weight/Wheel
 <p>Single Double</p>	WU-080U16	single	78	35	20	16.6	85	300kg (2 wheels)	0.790	
	WU-080U20D	double	78	36	25	20.6	85	600kg (2 wheels)	0.940	
	WU-100U20D	double	98	38	25	20.6	105	800kg (2 wheels)	1.620	
<p>Under Gate Wheels are bolted or welded to the under-side of sliding gates. Available in either single or double bearing wheels and zinc plated (ZP) for corrosion protection. (The "U" wheels are suited for use on "U" tracks.</p>										

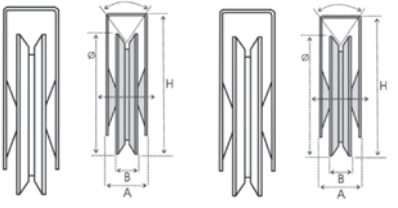
UNDER GATE WHEELS - Y		CODE	Bearing	Ø	o	A	B	H	Loading Capacity	Weight/Wheel
 <p>Single Double</p>	WU-080Y	single	78	92	35	20	85	300kg (2 wheels)	0.790	
	WU-080YD	double	78	92	36	25	85	600kg (2 wheels)	0.940	
	WU-100YD	double	98	92	38	25	105	800kg (2 wheels)	1.600	
<p>Under Gate Wheels are bolted or welded to the under-side of sliding gates. Available in either single or double bearing wheels and zinc plated (ZP) for corrosion protection. "Y" Wheels are designed for use on "V" tracks. The "Y" profile wheels provide superior running ability when compared with "V" wheels, especially on spoiled tracks.</p>										

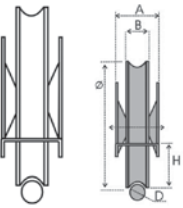
REBATE WHEEL - U		CODE	Bearing	Ø	A	B	D	H	Loading Capacity	Weight/Wheel
	WR-080U16	single	78	33	20	16.6	22	250kg (2 wheels)	0.775	
	WR-100U16	single	98	33	22	16.6	28	300kg (2 wheels)	1.3	
	WR-120U20	single	118	36	25	20.6	24	400kg (2 wheels)	2.185	
<p>Rebate Wheels are fixed to the underside of the sliding gate. The base of the gate should be cut through so that the wheel support can be recessed into the gate. The benefit of using the rebate wheels is that less of the wheel can be seen in the finished system. The "U" profile of rebate wheels are designed for use on the "U" tracks. Lynx Rebate wheels are zinc plated (ZP).</p>										

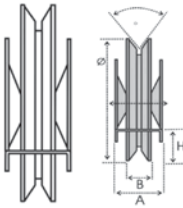
REBATE WHEEL - Y		CODE	Bearing	Ø	o	A	B	H	Loading Capacity	Weight/Wheel
	WR-080Y	single	78	92	33	20	22	250kg (2 wheels)	0.775	
	WR-100Y	single	98	92	33	22	28	300kg (2 wheels)	1.3	
	WR-120Y	single	118	92	36	25	24	400kg (2 wheels)	2.185	
<p>Rebate Wheels are fixed to the underside of the sliding gate. The base of the gate should be cut through so that the wheel support can be recessed into the gate. The benefit of using the rebate wheels is that less of the wheel can be seen in the finished system. The "Y" profile of rebate wheels are designed for use on the "V" tracks. Lynx Rebate wheels are zinc plated (ZP).</p>										



PIPE (CHS)

Fence and Gate Hardware

All sizes are in millimeters (mm) and weights are in kg's unless stated otherwise.
Specifications subject to change without notice.

28

PIPE (CHS)

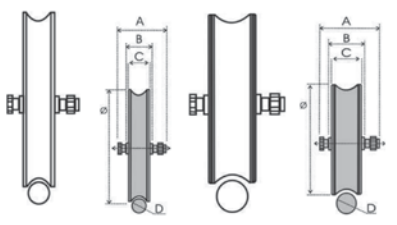
NO SUPPORT WHEELS - U										
		CODE	Bearing	Ø	A	B	C	D	Loading Capacity	Weight/Wheel
Single	Double	WB-080U16	single	78	12*60	28	20	16.6	300kg (2 wheels)	0.600
		WB-080U20D	double	78	14*60	34	25	20.6	600kg (2 wheels)	0.740
		WB-100U20D	double	98	14*60	34	25	20.6	800kg (2 wheels)	1.320
		WB-120U20D	double	118	14*60	34	30	20.6	1000kg (2 wheels)	2.280

No Support Wheels are supplied with a bolt that allows the fixing of the wheel to the underside of the sliding gate. These "U" shaped wheels come in both single and double bearing options and are zinc plated (ZP), thus offering excellent corrosion protection. These U shaped No Support wheels are designed to be paired with the U shaped tracks.

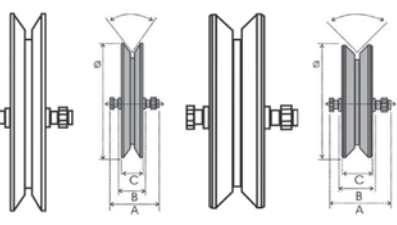
NO SUPPORT WHEELS - Y										
		CODE	Bearing	Ø	o	A	B	C	Loading Capacity	Weight/Wheel
Single	Double	WB-080Y	single	78	92	12*60	28	20	300kg (2 wheels)	0.600
		WB-080YD	double	78	92	14*60	34	25	600kg (2 wheels)	0.740
		WB-100YD	double	98	92	14*60	34	25	800kg (2 wheels)	1.320
		WB-120YD	double	118	92	14*60	34	30	1000kg (2 wheels)	2.260

No Support Wheels are supplied with a bolt that allows the fixing of the wheel to the underside of the sliding gate. These "Y" shaped wheels come in both single and double bearing options and are zinc plated (ZP), thus offering excellent corrosion protection. These Y shaped No Support wheels are designed to be paired with the V shaped tracks.

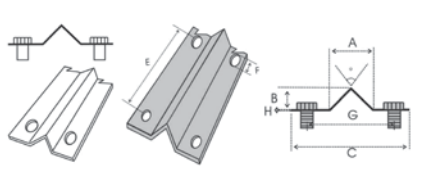
SLIDING GATE V TRACK													
		CODE	# of Fixing Holes	o	A	B	C	E	F	G	H	Length	Weight
		TSV-3000	24	90	28.8	14.5	59.5	300	6.5*11	40	3	3000	4.36

V Tracks are bolted to a stable surface and allow a sliding gate with attached V wheels to slide over it smoothly. Lynx tracks are made from pre-galvanised (PG) steel.

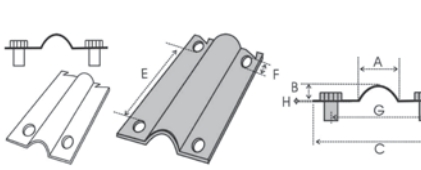
SLIDING GATE U TRACK												
		CODE	# of Fixing Holes	A	B	C	E	F	G	H	Length	Weight
		TSU-3000-16	24	16	16	55	300	6.5*11	40	3	3000	4.36
		TSU-3000-20	24	20	16	55	300	6.5*11	40	3.5	3000	4.98

U Tracks are bolted to a stable surface and allow a sliding gate with attached V wheels to slide over it smoothly. The U tracks come in two sizes, 16mm and 20mm curve diameter. The wheels used will determine the track you need and vice-versa. Lynx tracks are made from pre-galvanised (PG) steel.

PIPE (CHS)

Fence and Gate Hardware

All sizes are in millimeters (mm) and weights are in kg's unless stated otherwise.
Specifications subject to change without notice.

29

PIPE (CHS)

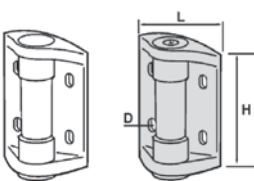
SELF-CLOSING HINGE-NYLON		CODE	Close Capacity	D	H	L	Weight
	H.TC.R (pair)	up to 25kg	5.5	97	61	0.450	
	H.TC.H (pair)	up to 60kg	7	126	88	0.550	
<p>A range of nylon self closing hinges with stainless steel internal springs makes these hinges the most popular choice for pool gates. These hinges are tension adjustable.</p>							

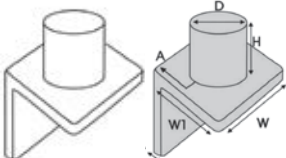
ANGLE GUDGEON		CODE	D	H	A	W	T	Weight	Qty Bag	Qty Box	Box WT
	AG25	25	30	33	56	5	0.280	10	40	18	
	AG33	33	40	38	56	6	.0560	10	40	22	
<p>Angle Gudgeons are welded to a gate post. The gate is then fitted over the gudgeon, acting as a hinge. Lynx Angle Gudgeons are 100% hot dipped galvanized (HDG).</p>											

PIPE (CHS)

Fence and Gate Hardware

All sizes are in millimeters (mm) and weights are in kg's unless stated otherwise.
Specifications subject to change without notice.

C LATCH

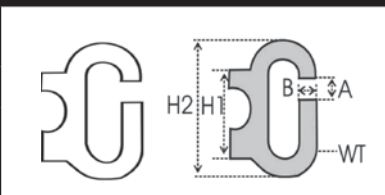

CODE	H1	H2	A	B	WT	Weight	Qty/Bag	Qty/Box	Box WT
C-Latch	49	64	10.5	10	5	0.060	20	200	

The Weld-on C Latch is typically welded to a fence post and allow for the attachment of a chain acting as a gate fastener. The Lynx C Latch is 100% hot dipped galvanised (HDG).

PAD BOLT

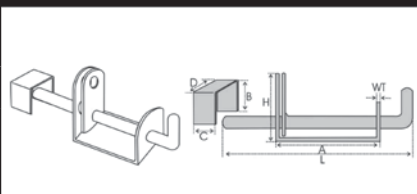

CODE	A	B	C	D	H	WT	Weight	Qty/Bag	Qty/Box	Box WT
PB225-W							0.780	10		

The Pad Bolt is a heavy duty gate fastener that is welded to both the gate (bolt attachment) and the post, or other structure (the "U" section). The Lynx Pad Bolt is 100% hot dipped galvanised (HDG).

GATE PIVOT HINGES - BOLT ON AND WELD ON

CODE	A	B	C	D	E	F	G	H	INT	Weight	Qty/Bag	Qty/Box	Box WT
GPB-18	51-70	M18	16	90	14	6	43	27	70	0.660	2	40	26
GPW-18	51-70	M18	16	32	14	6	43	27	-	0.500	2	40	20

The "c" section of the hinge is welded to the gate & the opposite side is then welded or bolted to the gate post. After installing, the gate position can be horizontally adjusted through the adjustable nut. The Lynx Gate Pivot Hinges are zinc plated (ZP).

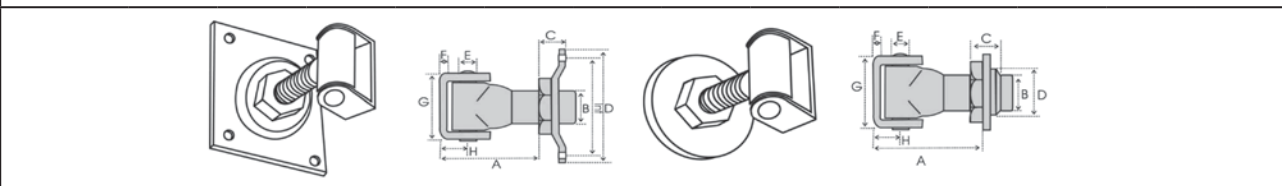

EYE TO EYE TURN BUCKLE

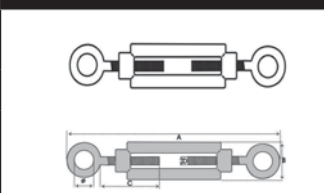

CODE	A	B	C	D	Ø	Weight	Qty/Bag	Qty/Bag	Box WT
TB12F.EE	225	34	85	12	17	0.360	10	50	19

Turn Buckles are used to draw wire lengths tight. The eye-to-eye style has eyes on both ends of the buckle. Lynx Turn Buckles are forged (not cast) and hot dipped galvanised (HDG). They are both exceptionally strong and long-lasting.

30

PIPE (CHS)